



DR4100

433.92 MHz Transmitter Module

- **Designed for Short-Range Wireless Data Communications**
- **Supports up to 115.2 kbps Encoded Data Transmissions**
- **3 V, Low Current Operation plus Sleep Mode**
- **Ready to Use OEM Module**

The DR4100 transmitter module is ideal for short-range wireless data applications where robust operation, small size and low power consumption are required. The DR4100 utilizes RFM's TX5000 amplifier-sequenced hybrid (ASH) architecture to achieve this unique blend of characteristics. The transmitter includes provisions for on-off keyed (OOK) and ASK modulation. The transmitter employs SAW filtering to suppress output harmonics, facilitating compliance with ETSI 300 220 and similar regulations. The DR4100 includes the TX5000 plus all configuration components in a ready-to-use PCB assembly, excellent for prototyping and intermediate volume production runs.

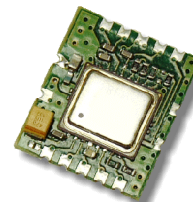

Absolute Maximum Ratings

Rating	Value	Units
Power Supply and All Input/Output Pins	-0.3 to +4.0	V
Non-Operating Case Temperature	-50 to +100	°C
Soldering Temperature (10 seconds)	230	°C

Electrical Characteristics, 2.4 kbps On-Off Keyed

Characteristic	Sym	Notes	Minimum	Typical	Maximum	Units
Operating Frequency	f_o		433.72		434.12	MHz
Data Rate	OOK				19.2	kbps
	ASK				115.2	
Transmitter Performance (OOK @ 2.4 kbps)						
Peak Input Current, 3 Vdc Supply	I_{TP}				12	mA
Peak Output Power	P_O			0.75		mW
Turn On/Turn Off Time	t_{ON}/t_{OFF}				12/6	μ s
Power Supply Voltage Range	V_{CC}		2.7		3.5	Vdc
Operating Ambient Temperature	T_A		-20		+65	°C

DR4100 Pin Out

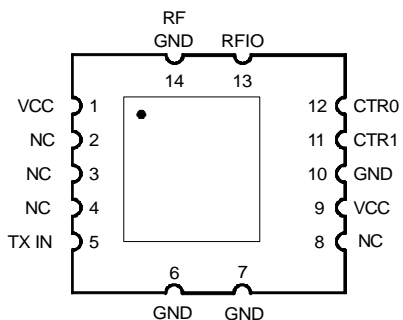

DR4100 Outline Drawing

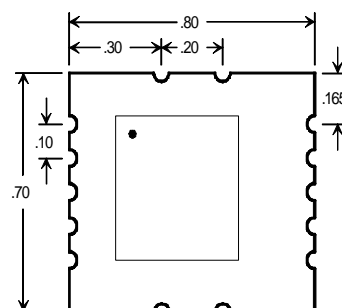

Pin Descriptions

Pin	Name	Description
1	VCC	
5	TX IN	<p>The TX IN pin is connected to the transmitter TXMOD pin through a 4.7 K resistor on the circuit board. Additional series resistance will often be required between the modulation source and the TX IN pin, depending on the desired output power and peak modulation voltage (3.3 K typical for a peak modulation voltage of 3 volts). Saturated output power requires about 450 μA of drive current. Peak output power P_O for a 3 Vdc supply is approximately:</p> $P_O = 4.8 * ((V_{TXH} - 0.9) / (R_M + 4.7))^2$ <p>where P_O is in mW, peak modulation voltage V_{TXH} is in volts and external modulation resistor R_M is in kilohms</p> <p><i>This pin must be held low in the receive and sleep modes. Please refer to section 2.9 of the ASH Transceiver Designer's Guide for additional information.</i></p>
6, 7	GND	
8	NC	
9	VCC	This is the positive supply voltage pin for the module. The operating voltage range is 2.7 to 3.5 Vdc. It is also possible to use Pin 1 as the Vcc input. Please refer to the Pin 1 description above.
10	GND	This is the supply voltage return pin.
11	CTR1	CTR1 and CTR0 select the transmit modes. CTR1 high and CTR0 low place the unit in the ASK transmit mode. CTR1 low and CTR0 high place the unit in the OOK transmit mode. CTR1 and CTR0 both low place the unit in the power down (sleep) mode. CTR1 is a high-impedance input (CMOS compatible). An input voltage of 0 to 200 mV is interpreted as a logic low. An input voltage of Vcc - 200 mV or greater is interpreted as a logic high. An input voltage greater than Vcc + 200 mV should not be applied to this pin. This pin must be held at a logic level; it cannot be left unconnected.
12	CTR0 (T/S)	"T" =1 for transmission, "S" =0 for sleep mode
13	RFIO	RFIO is the RF output pin. A matching circuit for a 50 ohm load (antenna) is implemented on the circuit board between this pin and the transceiver SAW filter transducer.
14	RF GND	This pin is the RF ground (return) to be used in conjunction with the RFIO pin. For example, when connecting the module to an external antenna, the coaxial cable ground is connected this pin and the coaxial cable center conductor is connected to RFIO.

