

LR1276 Module Datasheet v1.2

Features

- LoRaTM Modem
- 168 dB maximum link budget
- +20 dBm - 100 mW constant RF output vs. V supply
- +14 dBm high efficiency PA
- Programmable bit rate up to 300 kbps
- High sensitivity: down to -148 dBm
- Bullet-proof front end: IIP3 = -11 dBm
- Excellent blocking immunity
- Low RX current of 9.9 mA, 200 nA register retention
- Fully integrated synthesizer with a resolution of 61 Hz
- FSK, GFSK, MSK, GMSK, LoRaTM and OOK modulation
- Built-in bit synchronizer for clock recovery

- Preamble detection
- 127 dB Dynamic Range RSSI
- Automatic RF Sense and CAD with ultra-fast AFC
- Packet engine up to 256 bytes with CRC
- Built-in temperature sensor and low battery indicator

Applications

- Automated Meter Reading.
- Home and Building Automation.
- Wireless Alarm and Security Systems.
- Industrial Monitoring and Control
- Long range Irrigation System

Description

The LR1276 module is designed based on SX1276. The SX1276 incorporates the LoRaTM spread spectrum modem which is capable of achieving significantly longer range than existing systems based on FSK or OOK modulation. At maximum data rates of LoRaTM the sensitivity is 8dB better than FSK, but using a low cost bill of materials with a 20ppm XTAL LoRaTM can improve receiver sensitivity by more than 20dB compared to FSK. LoRaTM also provides significant advances in selectivity and blocking performance, further improving communication reliability. For maximum flexibility the user may decide on the spread spectrum modulation bandwidth (BW), spreading factor (SF) and error correction rate (CR). Another benefit of the spread modulation is that each spreading factor is orthogonal - thus multiple transmitted signals can occupy the same channel without interfering. This also permits simple coexistence with existing FSK based systems. Standard GFSK, FSK, OOK, and GMSK modulation is also provided to allow compatibility with existing systems or standards such as wireless MBUS and IEEE 802.15.4g.

Block Diagram

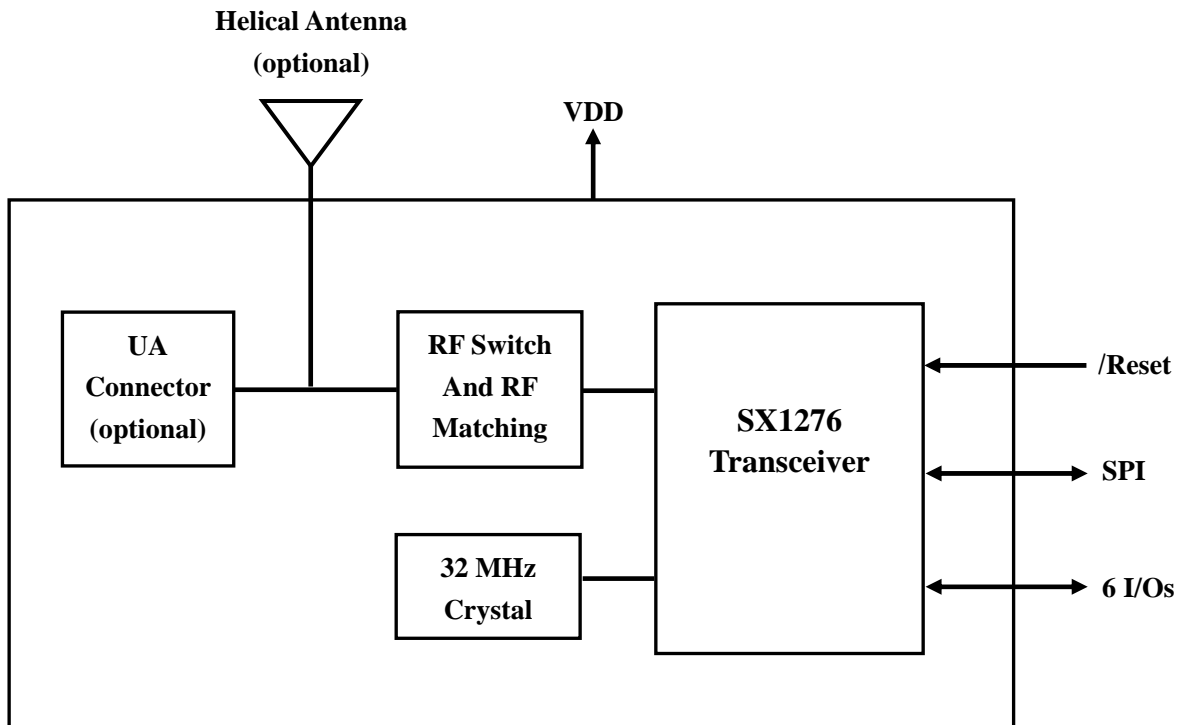

Specifications

Parameter		Min	Typ	Max	Unit	
Operating Voltage		1.8	-	3.7	V	
Operating Temperature		-40	-	+85	°C	
Current Consumption	Sleep Mode	-	0.2	1	uA	
	Idle Mode (RC oscillator enabled)	-	1.5	-	uA	
	Standby Mode (Crystal oscillator enabled)	-	1.6	1.8	mA	
	Receive mode	LnaBoost Off, band 1	-	10.8	-	mA
		LnaBoost On, band 1	-	11.5	-	
Bands 2&3		-	12.0	-		
Transmit Mode (RFOP =+20dBm, on PA_BOOST)	-	120	-	mA		
TX Power (For Lora Modulation)		-	-	19	dBm	
RX Sensitivity (For Lora Modulation)		-	-	-139	dBm	

Module Information and Mechanical Drawing

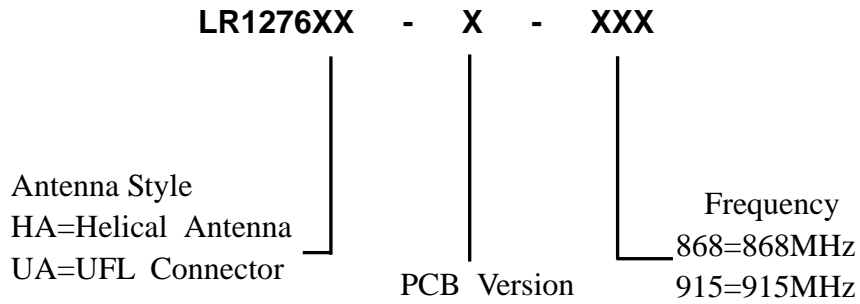

LR1276HA-A-868/915:

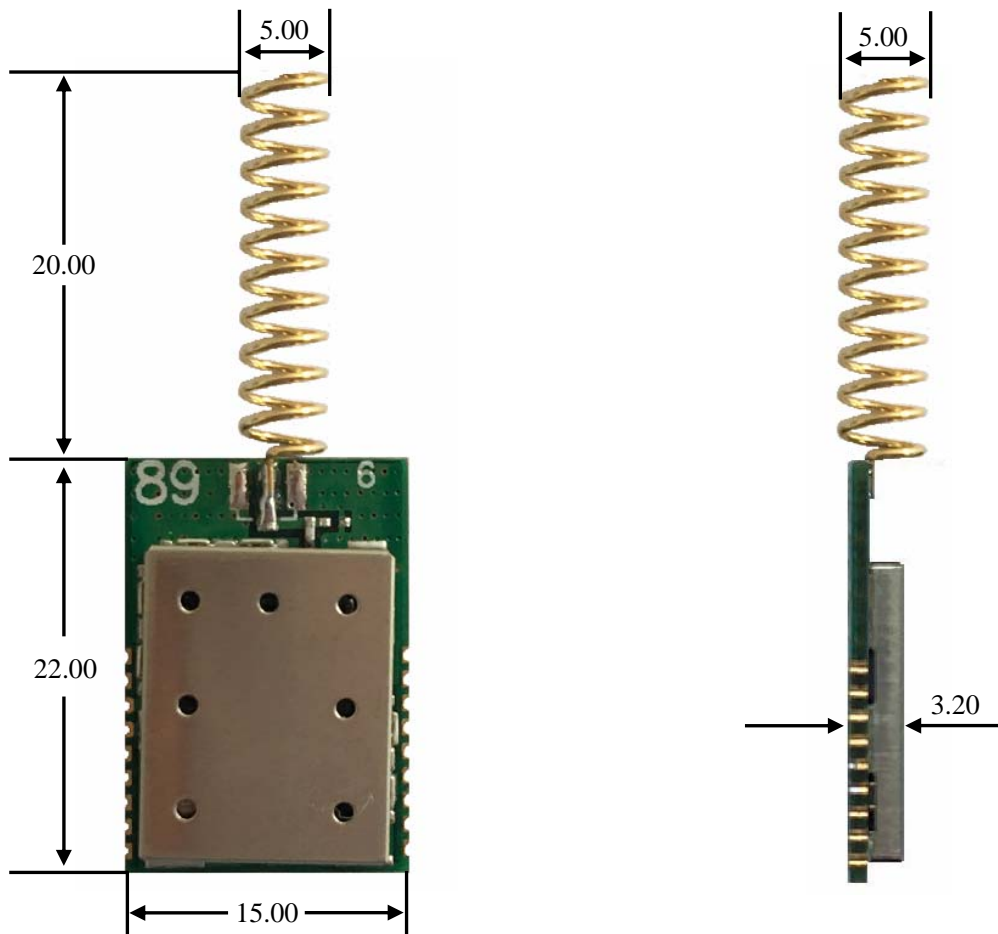

Unit: mm
 Tolerance: $\pm 0.2\text{mm}$

LR1276UA-A-868/915:

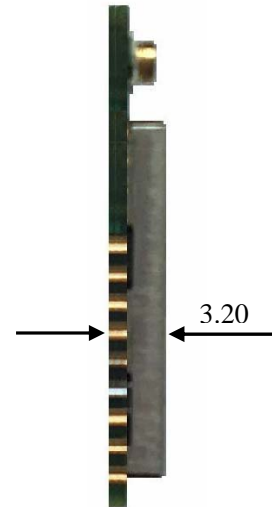
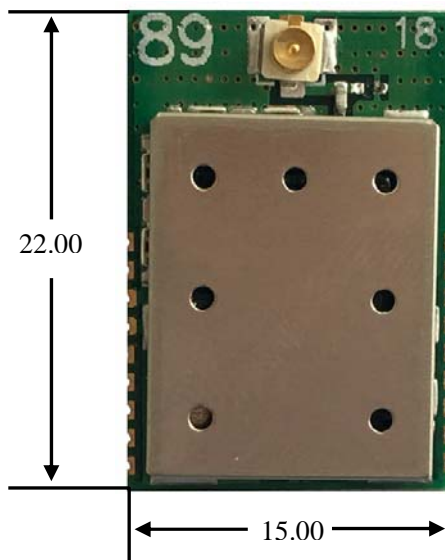

Unit: mm
 Tolerance: $\pm 0.2\text{mm}$

Terminal Description

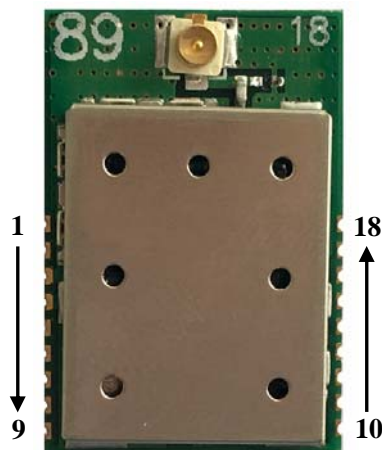

Pad Number	Name	Pin Type	Description
1	TX_ENABLE	I	Tx Switch Control: High in Tx
2	VDD	Power	1.8V to 3.7V main chip supply
3	GND	Ground Pin	Connect to GND
4	GND	Ground Pin	Connect to GND
5	NRESET	I/O	Reset Trigger Input
6	DIO0	I/O	Digital I/O, Software configured

7	DIO1/DCLK	I/O	Digital I/O, Software configured
8	DIO2/DATA	I/O	Digital I/O, Software configured
9	DIO3	I/O	Digital I/O, Software configured
10	DIO4	I/O	Digital I/O, Software configured
11	DIO5	I/O	Digital I/O, Software configured
12	SCK	I	SPI Clock Input
13	MISO	O	SPI Data Output
14	MOSI	I	SPI Data Input
15	NSS	I	SPI Chip Select Input
16	RXTX/RF_MOD	O	Rx/Tx Switch Control: High in Tx
17	NC	-	No Connect
18	RX_ENABLE	I	Rx switch Control: High in Rx

Recommended PCB Layout for Package

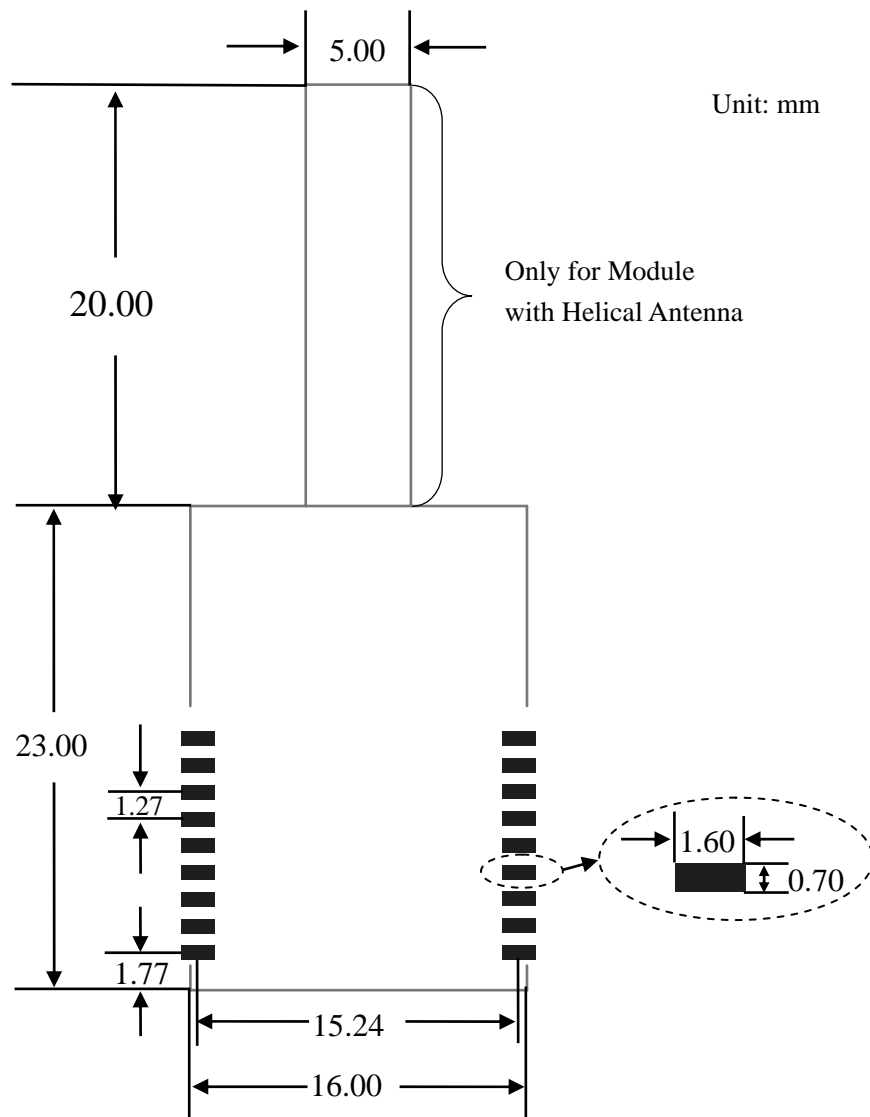

Recommended Reflow Profile for Lead Free Solder

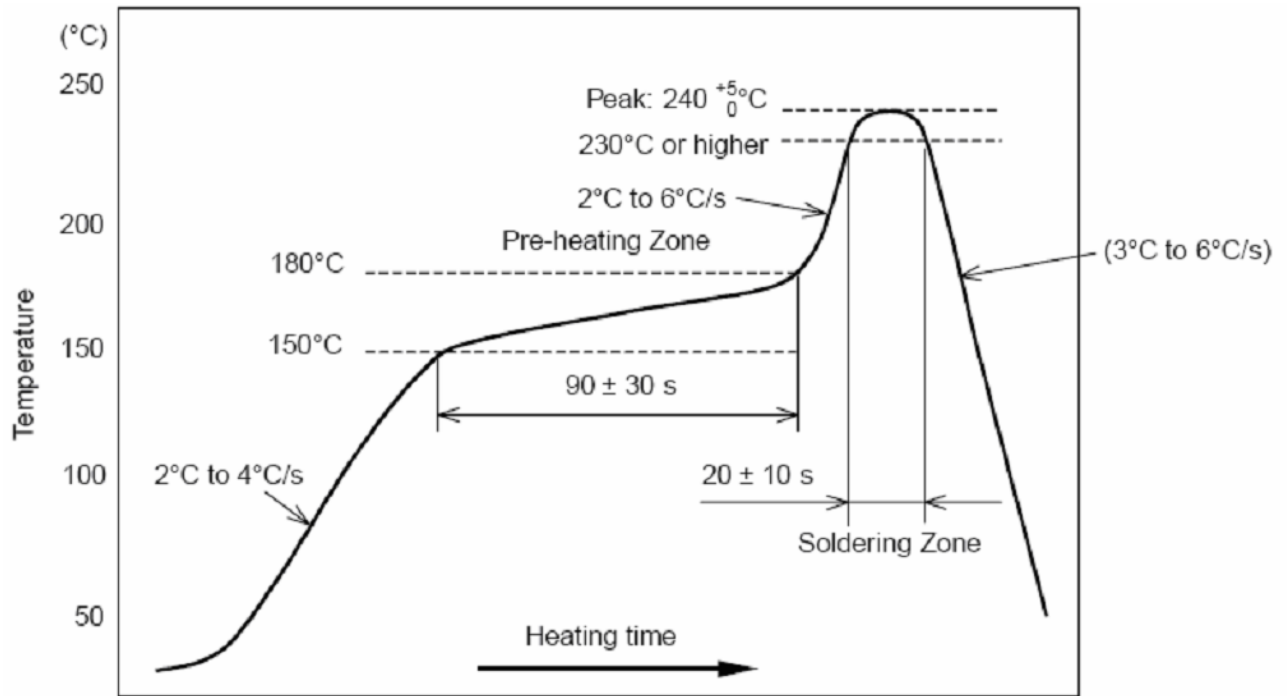

Contact details

For more information, please send email to us.

Email:

Sales@rf-products.com

Helen@rf-products.com